

Component Award 2019 - Window of the Future

Dr.-Ing. Benjamin Krick, M.Arch. Soraya Lopez, M.Arch. Edward Lowes, PHI
Rheinstraße 44/46, 64283 Darmstadt, Germany
Phone: +49 (0) 6151 82699-0; mail@passiv.de

The Award

Aim: Thermally improved windows for all. In recent years, excellent progress has been made with reference to the thermal quality of windows. In order to make a significant contribution to climate protection, these further improved windows must enter the global mainstream. To create an impetus and contribute to the accelerated uptake of windows that represent the cutting edge in terms of thermal efficiency, the Passive House Institute has conducted this award as part of the AZEB-Project, supported by the European Union.

Method: Comparison with a baseline window. Participants had to provide a certified Passive House window solution, including installation and shading, in the category “tilt & turn” window and in addition in the category “window combination”. Each window was compared by its life cycle costs and CO₂ savings with a baseline window, which is standard at the participant’s location. A specialist jury evaluated the topics innovation, practicability, aesthetics and made the final decision regarding categories and winners. Members of the jury were: Prof. L. Rongen, Prof. H. Krause, D. Michulec, M.Sc. S. Sheng, M.Arch. E. Lowes. And as consultants M.Arch. S. Lopez and Dr. B. Krick.

Participants: Windows from all over the world. In sum, 23 companies from 12 countries took part in the competition with 31 products and variants. Among the products were 21 Timber Aluminium, 6 Aluminium, 3 Timber and 1 Plastic windows. For the arctic climate zone, one window was entered, 6 for cold, 14 for cool, temperate, 8 for warm, temperate and 2 warm windows. The jury awarded 10 regular prizes and 3 special prizes.

The Findings

Life cycle analysis: Investment- and operation costs

Due to different price levels of building costs all over the world in general, for passive house windows in particular, as well as the high variation of the proposed baseline windows, the jury found it hard to decide according to make decisions based on the life-cycle costs. In some cases this lead to questionable results. For instance in New Zealand, timber aluminium windows are not common. So, the baseline window to compare with the passive house window might be a timber or an aluminium window. In the case of comparing the passive house window with a traditional timber window, the passive house window turns out to be very affordable while comparing with a mass-produced aluminium window, the differences of the life cycle costs are much closer. In China, the labour- and thus the construction costs are, compared to North America or Europe, relatively low. So the costs of both, reference- as well as passive house windows and their installation are also low. The energy costs on the other hand were set as equal all over the world. That leads to a relatively high influence of the energy costs in markets with low window prices; passive house windows seemed to be much

more beneficial in those markets. In such cases, the jury took the liberty to carefully interpret the results.

The choice of the heating system has a strong effect on the life cycle costs, too, as well as on the CO₂ emissions. For the award, an oil-fired boiler was taken into account for the life cycle analysis and to estimate the CO₂ emissions. The costs per kWh of heating energy were assumed as 9.8 €Cent per kWh, including 2.4 €Cent CO₂ compensation costs. However, for instance in New Zealand (south island near Christ Church, no cooling required), in the majority of cases electricity is used rather than oil-fired boiler is used for heating, either direct or via a heat pump. Figure 1 shows the life cycle costs and CO₂ savings of ThermaDura NatureLine (winner of the Special Prize Economy) in combination with different heating systems.

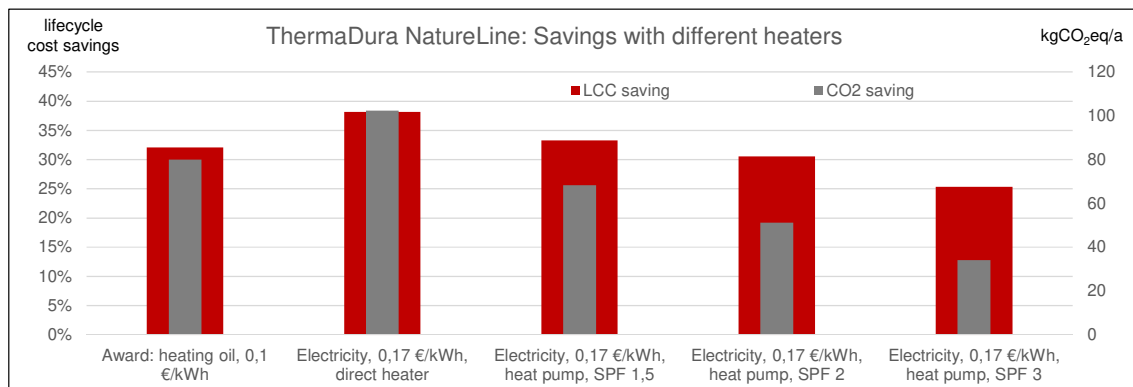

Figure 1: Life cycle cost and CO₂ savings for ThermaDura NatureLine with different heaters. Price of electricity: 17 €Cent/kWh, 450 gCO₂eq/kWh. ©PHI 2019

It can be seen that, in case of a direct electric heater and a poor heat pump, the life cycle costs are higher than as with the awards scenario. But if good heat pumps are used, the life cycle costs are lower than for the awards scenario. It should be noted, that no CO₂ compensation costs were taken into account in the price for electricity, nor the different investment costs for the heaters.

Cooling was taken into account with both a very low energy price (10 €Cent/kWh) and low CO₂ emissions (63 gCO₂eq/kWh), as it was assumed that a relatively efficient heat pump (SPF 2.5), powered by PV panels was used. Figure 2 shows the savings for smartwin compact double by Daimaru Kogyo Ltd., Japan with different cooling- and heating systems. Here too, no CO₂ compensation costs were taken into account for the real electricity price in Japan (for heating and cooling) of 21 €Cent/kWh. The CO₂ emissions of Japans electricity were taken into account with 520 gCO₂eq/kWh.

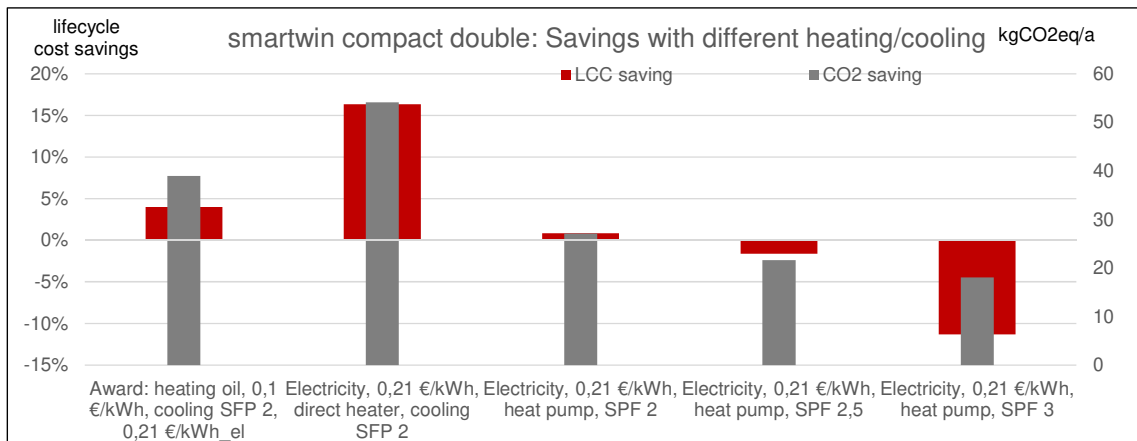

Figure 2: Life cycle cost and CO₂ savings for smartwin compact by Daimaru Kogyo LTD, Japan with different heaters/chillers. ©PHI 2019

It can be observed that, with the exception of the direct heating with a relatively poor performing heat pump for cooling, there are only few or even negative life cycle cost savings. Furthermore, it appears that the cooling costs are higher for the smartwin than for the standard window. This is due to the higher glass fraction of the smartwin and glazing with a higher g-value.

Figure 3 shows a variation where the size of the smartwin window is reduced to match the glazing area of the baseline window; the investment costs are equally reduced and the glazing is U-value optimized: 1.04 W/(m²K), g = 45%. Now, only with the very good heat pump are the life cycle cost savings lower than in the award scenario and even then, there is a life-cycle benefit for the customer.

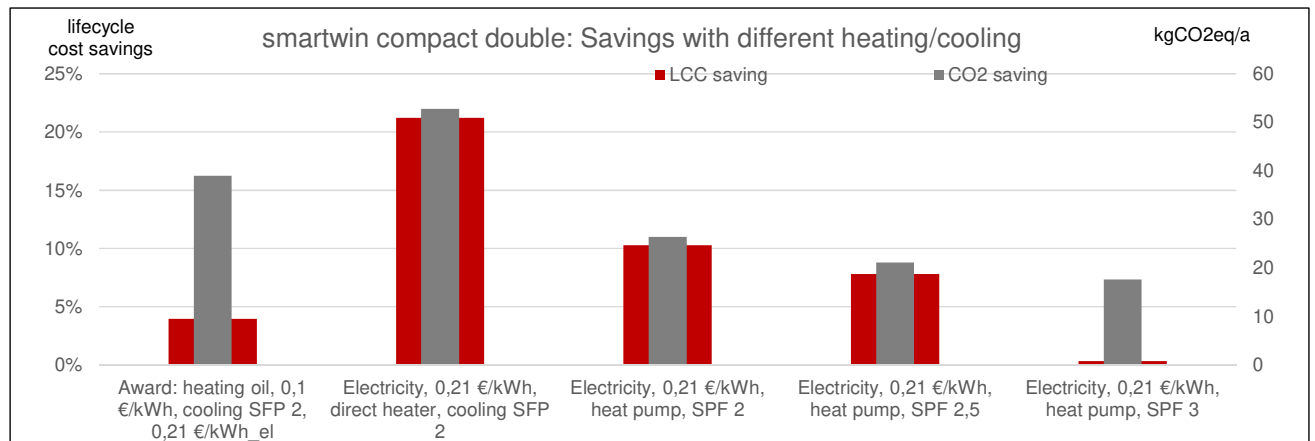

Figure 3: Life cycle cost and CO₂ savings for smartwin compact by Daimaru Kogyo Ltd., Japan with different heaters/chillers, adjusted window size and U-value optimized glazing. ©PHI 2019

In China the situation is different. Here, coal at a cost of only 700 Yuan/tonne is used. With the CO₂ compensation cost used in the award, this results in 75 €/tonne and an efficiency factor of the heating system of 1.25, in a heat price of 5.3 €Cent/kWh. So, the achievable CO₂ savings are reduced. Because of the higher CO₂-factor of coal compared to heating oil, the CO₂ savings are increasing at the same time, see figure 4 which is showing at the example of Moser 115 by Hebei Orient Sundar, the winner of the first prize in the category Aluminium cool, temperate climate.

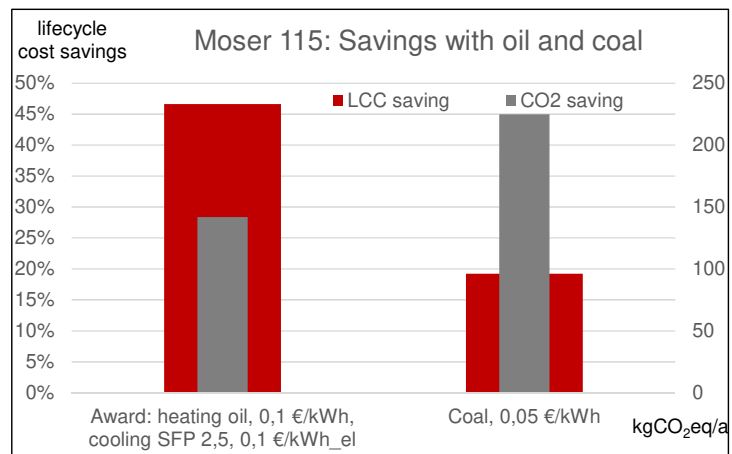

Figure 4: Life cycle cost and CO₂ savings for Moser 115 with awards boundary conditions and standard used coal heating. ©PHI 2019

Installation

While the installation of the baseline windows shows in nearly every case extremely high level of thermal bridging (installed in the load-bearing layer with no reveal insulation), most of the Passive House windows show very good results, thus installed in or partially in the insulation layer with the frame covered by the insulation of the wall. It must be noted that the installation situation has a significant effect on both, the windows' energy balance as well as their economic success. This highlights the need for a very well designed installation and a high quality craftsmanship, not only in terms of thermal bridges but also for airtightness.

In principle 5 different solutions for window installation were presented:

1. Installation by steel brackets: steel angles were screwed to the concrete wall, as well as to the window frame. Due to the high conductivity of steel, the angles can lead to high level of thermal bridging. In addition, it is necessary to fit the insulation well to the angles to avoid gaps caused by the angles and screws between insulation, wall and frame. If the angles are placed in the glue layer, if they do not penetrate the insulation layer of the window frame and countersink screws are used, the additional thermal losses will be in an acceptable range. In some cases, the windows bottom section is supported by a timber beam.
2. Installation by plywood boards: plywood boards are connected to the frame and fastened to the load bearing layer, becoming the window sill as well as reveal cladding. In this way, the frame can be positioned in the insulation layer, causing only neglect able thermal bridges. As the plywood is visible, it has to be installed very carefully. Without further measures, the screws are visible. Reinforcing elements might have to be used in bigger windows. This method can also be used in replacing old windows with new ones.
3. Installation by blind frame: a blind frame, for instance from highly rigid EPS foam is glued and screwed in the insulation layer, to the construction layer. The blind frame acts as clean surface on which the window can be mounted and to which the

airtightness layer can be connected. The window can be easily replaced by a new one when time comes. In addition, the high density EPS foam presents a level of additional sound protection. Reinforcing elements might have to be used in bigger windows.

4. Installation partially in the construction layer: if the frame is deep and outside insulated it is possible to install it partially in the load bearing layer with. The frame can then be directly fitted in the load bearing layer without additional elements, which makes the installation easy and cheap. It is important that the insulation layers of the frame and wall overlap as much as possible.
5. Block-out in the construction layer: to further improve the installation (partly) in the load bearing layer, Qingdao Rocky Window Ltd. has presented a practical solution: a bar, combined of resolic foam and timber blocks is used as part of the concrete formwork to make an insulating frame all around the window opening to which the window is connected. This solution represents an opportunity to install the window in the load bearing without a high level of thermal bridging. It is to be noted however, that the window will be further shaded by the deeper reveal and overhang.

Figure 5 shows the different approaches with the respective thermal bridge coefficients and heating costs. It can be seen that, the more the isothermal lines deviate, the greater the thermal bridge. The share of installation costs, additional installation costs as well as life cycle costs can also be seen, but it is important to note, that these data points are not fully comparable due to the different contexts. For instance with Rocky 110, the installation of a shutter housing is included in the installation costs of the baseline window, but Rocky 110s has an integrated shading with lower installation costs, which results in negative additional installation costs.

Case	Typical baseline	Steel brackets	Plywood board	Blind frame	Partially in constr. layer	Block-out in constr. layer
	Double alu, China	Pazen120, China	smartwin, Japan	Timm, Germany	Cascadia, Canada	Rocky110s, China
Model						
Isothermal map						
ψ [W/(m ² K)]	0,170	0,007	-0,002	0,013	0,033	0,023
Energy costs [€/m ² a]*	1,29 €	0,05 €	- 0,02 €	0,10 €	0,25 €	0,17 €
Life-cycle energy costs [€/window]**	162 €	7 €	- 2 €	12 €	31 €	22 €
Share of installation costs [%]	10%	12%	5%	17%	11%	6%
Additional installation costs, [€/window]	- €	55 €	22 €	106 €	- €	18 €
Life-cycle costs [€]	162 €	62 €	20 €	118 €	31 €	4 €

*0.10 €/kWh, 76 kWh/a. **Service life 40a, 3% real interest rate. Window size 1,23*1,48, all sides assumed with the same thermal bridge. The thermal bridge of installation depends also on the frame and on other factors. Because of that, the here presented values are not comparable.

Figure 5: Different installation strategies with their respective thermal bridge coefficients and resulting heating- and life-cycle costs. ©PHI 2019

Shading

The following shading solutions were used:

- In arctic/cold climate: venetian blinds (7), fabric screen (1)
- In cool, temperate climate: venetian blinds (8), fabric screen (3), roller blind (2), integrated shading (1)
- In warm, temperate climate: fabric screen (6), roller blind (1), integrated shading (2), classic blinds (1)

In the arctic, cold and cool, temperate climates, venetian blinds are predominant. In the case of direct attachment of the shutter housing to the wall, the thermal bridges are extremely high. The heat loss is more than 1 W/(mK), equivalent to 9 m² of undisturbed wall, resulting in life-cycle heating costs more than 200 € per window as figure 6 shows. With thermal separation, the situation can be improved to 0.28 W/(mK), equivalent to 2.3 m² wall and life cycle energy costs of 60 €. But as very good examples from the award show, the thermal bridge can be ten times smaller and thereby not much higher than without shutter housing.

Four measures are necessary for such a good result: 1. Use narrow shutter housings. 2. Move the shutter housing as far as possible to the outside. 3. Use a very good insulation between the wall and shutter housing. 4. Put the window in line with this insulation.

Case	Venetian blind				Fabric screen	
	Baseline with- out insulation	Baseline with insulation	Exemplary solution	Exemplary solution	Exterior housing	Housing in insulation layer
	Aluminium, China	Timber al., Germany	ENERsign primus	smartwin solar by i2	ThermaDura	smartwin
Model						
Isothermal map						
Ψ [W/(m ² K)]	1,094	0,278	0,024	0,025	0,063	0,055
Energy costs [€/m ² *a]*	8,31 €	2,11 €	0,18 €	0,19 €	0,48 €	0,42 €
Life-cycle energy costs [€/window]**	236 €	60 €	5 €	5 €	14 €	12 €
Share of instal- lation costs [%]	51%	29%	28%	26%	38%	18%
Costs for shading [€/window]	275 €	518 €	518 €	342 €	897 €	216 €
Wall with same loss as thermal bridge*** [m ²]	9,0 @U _{wall} = 0,15 W/(m ² K)	2,3 @U _{wall} = 0,15 W/(m ² K)	0,2 @U _{wall} = 0,15 W/(m ² K)	0,3 @U _{wall} = 0,12 W/(m ² K)	0,3 @U _{wall} = 0,25 W/(m ² K)	0,3 @U _{wall} = 0,25 W/(m ² K)

*0.10 €/kWh, 76 kWh/a. **Service life 40a, 3% real interest rate. The thermal bridge of installation depends also on the frame and on other factors. Because of that, the here presented values are not comparable.

Figure 6: Different shading solutions with their respective thermal bridge coefficients and resulting heating- and life cycle costs. ©PHI 2019

As we have seen, it is possible to get to low thermal bridge values in cool, temperate, cold and arctic climates. This is mainly because the insulation layer is thick enough to contain the shutter housing as described. In warm- or warm, temperate climates however, the insulation is thinner and therefore it is more difficult to insulate between the shutter housing and the wall.

To overcome this issue, several strategies were used in the award. The use of fabric screens instead of venetian blinds is one option, because the housing of a fabric screen is smaller. That might be the reason why fabric screens are predominant in warm, temperate and warm climates. ThermaDura connected a partially exterior housing directly to the frame, which reduces both thermal bridges and installation costs. The jury saw this solution as critical in terms of durability (water could drain between housing and plaster leading to moisture damages) and from an aesthetic perspective. Smartwin's solution is to simply turn the screen around, so that it rolls to the outside, creating the possibility of a thicker insulation between the roll and the wall. In this way, the thermal bridge can be reduced to around 0.06 W/(m²K), equivalent to 0.3 m² undisturbed wall in warm, temperate climate, see figure 6. Further improvements could be made by putting a piece of insulation in the lintel area of the concrete formwork.

Two manufacturers used integrated shading in different forms. This solution is very affordable, protect the shading device from weather and improves the U-value of the window. However, the cleaning of an additional pane, a higher level of winter time shading (by the

lamella when not in use) and a lower summer time shading (due to less efficiency caused by overheating of the air gap in which the blind is hosted) are taken into account. Furthermore, fixed glazing has to be shaded inside with reduced efficiency. One manufacturer used a traditional blind for shading, which seems to be a very good solution as it is relatively cheap and thermal bridges are insignificant.

The Winners

Arctic and cold climates

The Special Prize thermal protection was awarded to the quadruple glazed ENERsign arctis from ENERsign GmbH, Germany. The jury praised the high aesthetic standard in combination with the extraordinary thermal protection, which leads to CO₂ savings of 94% and the achievement of the hygiene, as well as the comfort criterion - even in the arctic climate of Kiruna/Sweden.

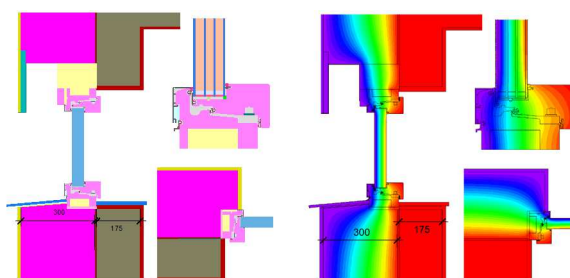

The 1st Prize for the cold climate was awarded to the window PAZEN120 from Harbin Sayyas Windows, China. The jury praised the high aesthetic standard in combination with high levels of thermal protection, which leads to CO₂ savings of 88% and to the achievement of the hygiene, as well as the comfort criterion, even in the harsh climate of Harbin.

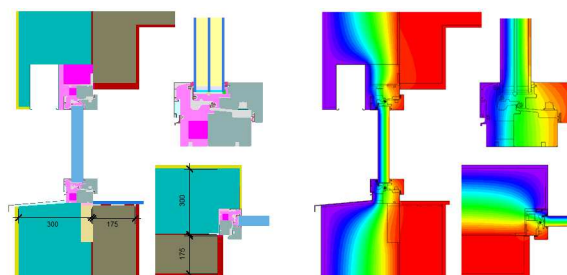

The 2nd Prize for the cold climate was awarded to the window smartwin solar by Advantage Architectural Woodworks (USA) and i2 factory (Latvia). The jury praised the high aesthetic and innovative standard in combination with high levels of thermal protection. The narrow frame allows a very high glass fraction of 80%.

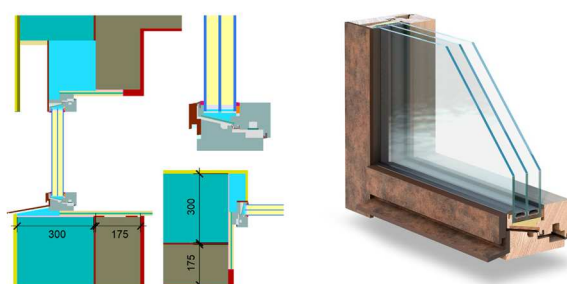

The 3rd Prize in Cold Climate was awarded to the window PURISTA ALPINE from Harbin OPTIWIN: Stich Consulting, Canada. The jury praised the high standard and clean installation situation in combination with the high level of thermal protection, energy and CO₂ savings.

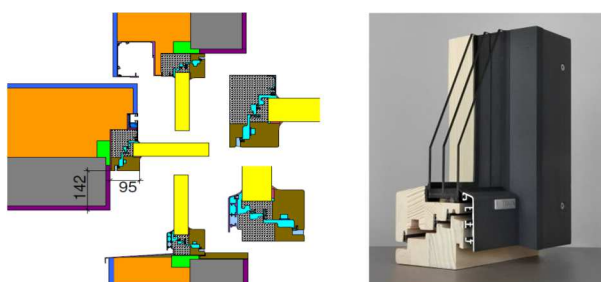

Cool, temperate climate: Timber Aluminium windows

The 1st Prize was awarded to ENERsign primus from ENERsign GmbH, Germany. The jury praised the high aesthetic standard in combination with the high level of thermal protection. Favourably judged was also the aesthetically pleasing integration of the shading and its assembly in the overall concept.

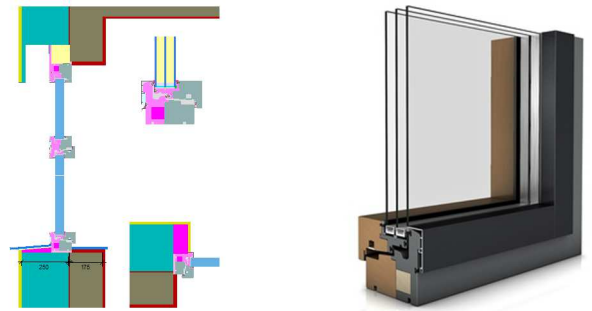

The 2nd Prize was awarded to the window TIMM C87 I –A/-H/-M + W87 –A/-H/-M by Timm Fensterbau, installed with Blaugelb Triotherm+ window mounting system by Meesenburg, Germany.

The jury praised the cost-efficient and low-maintenance shading, as well as the high standard and clean installation. For Germany, the jury indicated that a triple glazed window should have been used as baseline.

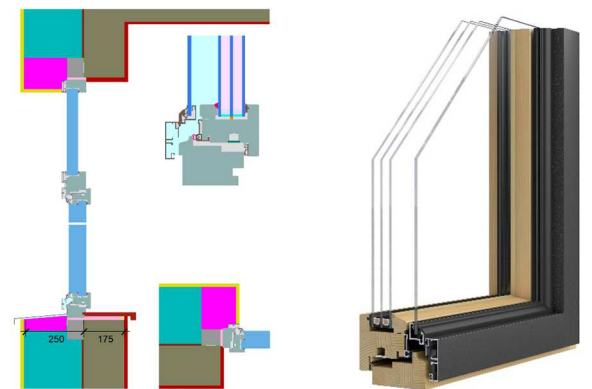

The 3rd Prize in Cold Climate was awarded to the window smartwin compact hpl triple by PARK Byoungyoel, Architecture Studio Time, Human and Space, Korea. The jury praised the high aesthetic and innovative standard in combination with high levels of thermal protection.



Cool, temperate climate: Aluminium and Plastic windows

The 1st Prize was awarded to Moser 115 Aluminum System Passive Window from Hebei Orient Sundar Window Co. Ltd., China. The jury praised the high aesthetic quality of the window concept with its slim frame as well as the energy and cost efficiency of this window. Care should be taken regarding the roller shutters connection with the plaster.

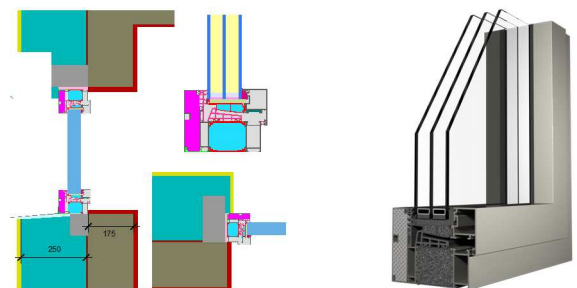

The 2nd Prize was awarded to the aluminium window Pural eco 90 by Beijing Wuddy Building Technology, China. The jury praised the high aesthetic quality of the window concept, as well as its energy and cost efficiency. The jury suggested to connect the frame to the shutter housings rigid EPS block to avoid steel brackets and decrease the degree of thermal bridges.

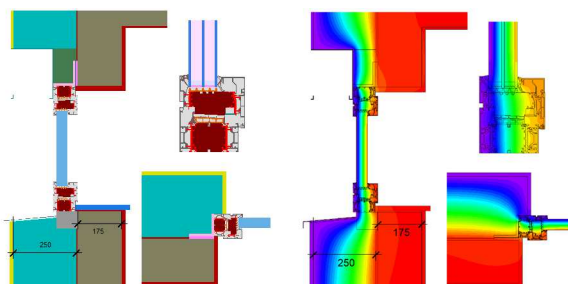

The Special Prize Aesthetic and Innovation was awarded to the GRP window Universal Series by Cascadia Windows Ltd., Canada. The jury praised the aesthetic and innovative qualities of this window concept, combined with very reasonable investment costs and its high energy and cost efficiency, especially compared to a relatively good baseline window.

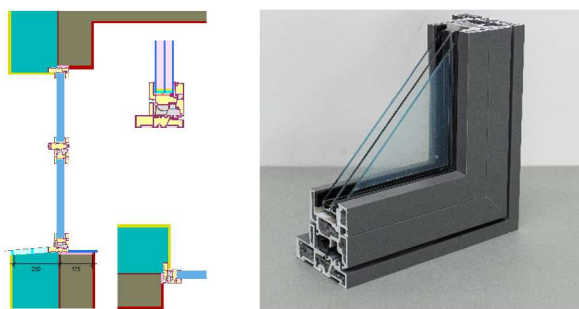

Warm, temperate climate: Timber Aluminium and Timber windows

The 1st Prize for Timber Aluminium Windows was awarded to smartwin compact by Daimaru Kogyo (Japan), Blumer Lehman (China) and SEDA (New Zealand). The jury praised the aesthetic and innovative standard in combination with high level of thermal protection and the innovative shading solution for this insulation thickness.



The 1st Prize for Timber Windows was awarded to ZEN by Eurofinestra s.a.s., Italy. The jury praised the highly innovative and aesthetic qualities of the window and shading concept. The jury underlined the exemplary life-cycle-cost savings in the warm, temperate climate zone, compared to a very high quality baseline window.

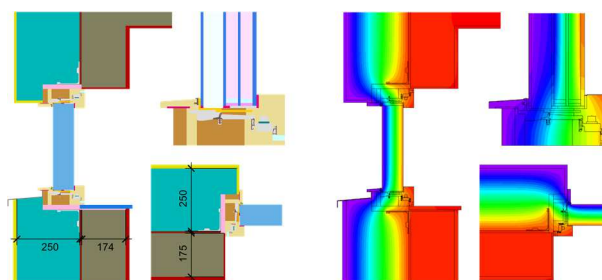

The Special Prize Economy was awarded to NatureLine by ThermaDura, New Zealand. The jury outlined the high quality of craftsmanship and practicability of window and window installation. Compared to a traditional, poor quality New Zealand wooden window, NatureLine has lower investment costs.

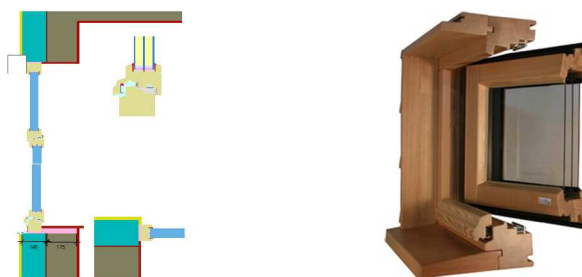

The Special Prize Shading & Installation was awarded to Rocky 110is by Qingdao Rocky Window, China. The jury praised both the innovative shading concept, where the blind is protected by a 4th pane, and the installation partially in the construction layer by a combination of wood blocks and highly insulating resolic foam for both, low level of thermal bridges, as well as easy and fast application.

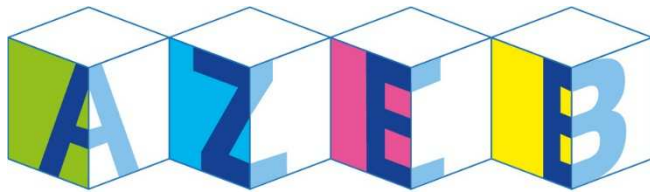
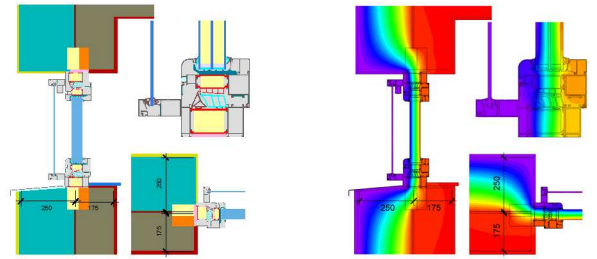

Affordable Zero Energy Buildings



This project has received funding from the European Union's Horizon 2020 research and innovation programme under grant agreement No 754174

Summary (300 characters)

The Award has been accomplished successfully. 23 companies from 12 countries took part with 31 products. The jury awarded 10 regular and 3 special prizes.

Findings: High live cycle cost as well as CO₂ savings are possible with passive house windows. Care has to be taken of thermal bridges caused by shutter housings. But the award showed excellent solutions.